

PNEUMATIC VALVES | Brass Heavy Duty PE Series

PE | Solenoid Operated

- Heavy duty brass valves, solenoid operated
- 3/2, 5/2, 5/3
- Port size : 1/4" & 1/2" BSP & NPT

Application

- Suitable for use in aggressive environments such as mining, cement manufacturing and flour milling industries.

Technical Data

Fluid	Air / Inert gas / Water
Operation pressure	-1 to 10 bar
Ambient temperature	-5° to 55° C (option for FKM seals) up to 150° C
Lubrication	Not required (use turbine oil class ISO VG32 if lubricated)
Port size	1/4" & 1/2" BSP or NPT
Flow rate (Air)	1/4" port size = 1,100 L/min (at 5.5 bar) 1/2" port size = 3,500 L/min (at 5.5 bar)
Coil voltage	6V DC & 12-24-48-110-120-230V AC/DC
Power consumption	26VA - 10W
Minimum pilot pressure	All valves : 3 bar



Sol-Spring



Sol-Air



Sol-Sol



3 position Closed Center

Construction

3 port Sol-Spring valve

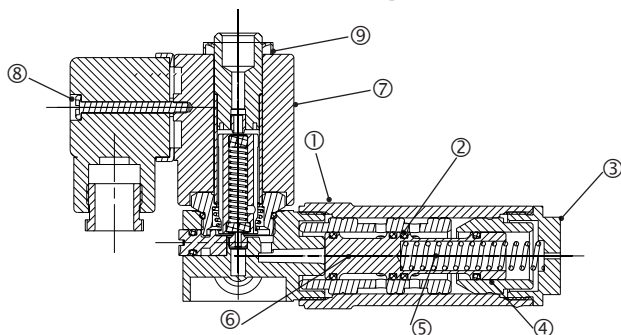

5 port Sol-Sol valve

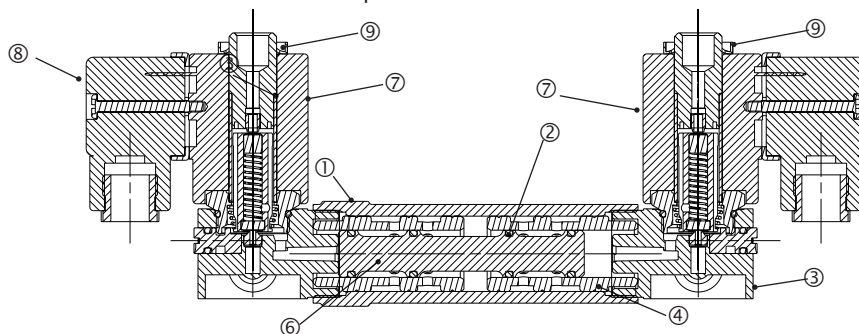

5 port, 3 Position Sol-Sol valve

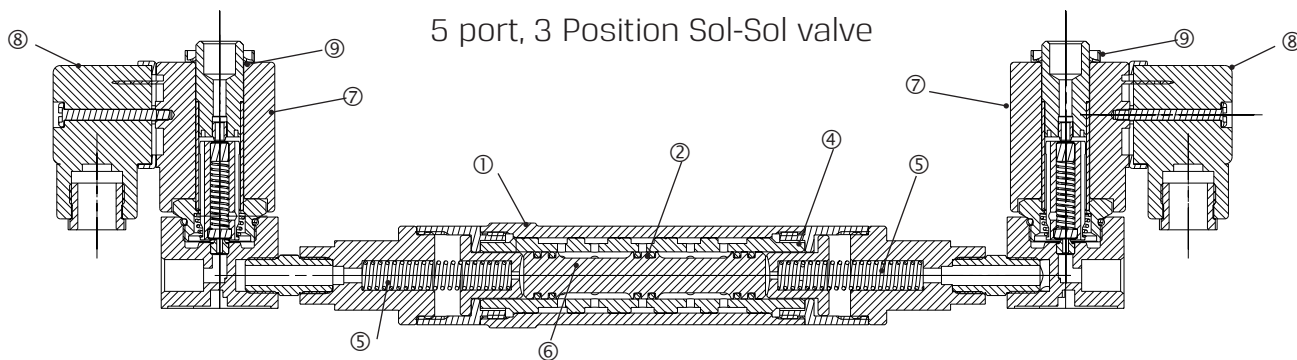

Component Parts

No.	Description	Material
1	Body	Brass *
2	"O" ring	NBR or FKM
3	End cover	Brass
4	Sleeve	Brass
5	Spring	-
6	Spool	Brass
7	Solenoid coil	
8	Connector	
9	Tightening	

* Painted with grey polyester

PNEUMATIC VALVES | Brass Heavy Duty

PE Series

PE | Solenoid Operated

PES3-S | Sol-Spring | 1/4", 1/2" | 3 port

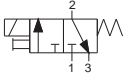

Port size : 1/4"

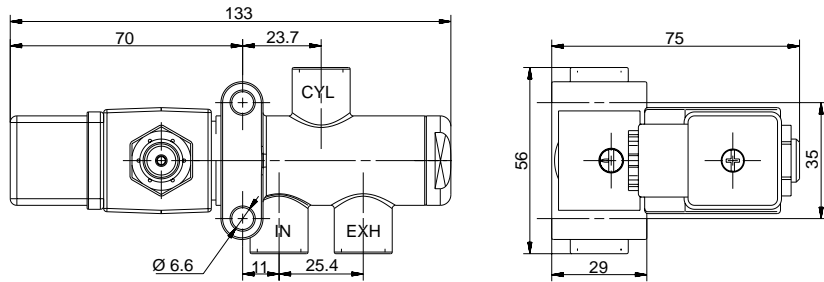

Port size : 1/2"

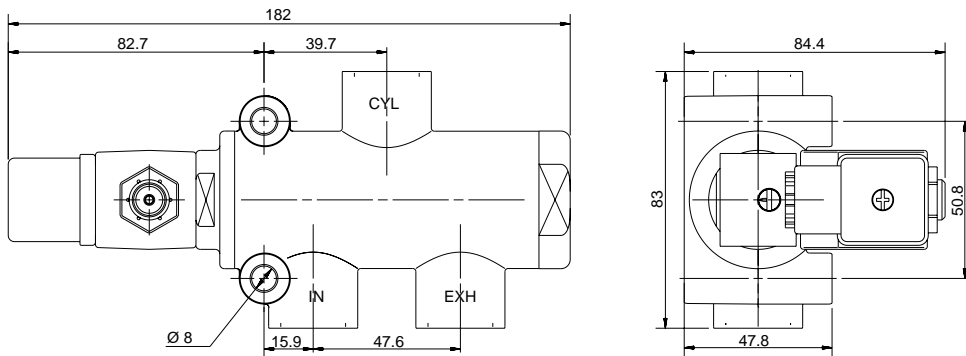

How to Order

PES3	PORT SIZE	S	SEAL MATERIAL	EXTERNAL AIR SUPPLY ⁽¹⁾	MANUAL OVERRIDE	COIL VOLTAGE	POWER	CONNECTOR		
	1/4" BSP	0	NBR	N	without	1	None	0	without	0
	1/4" NPT	1	FKM	V	with	2	Plastic	1	standard	1
	1/2" BSP	2					Brass slot	2 ⁽²⁾	with LED	2
	1/2" NPT	3					non-locking	3 ⁽²⁾	with LED + surge protection	3
							locking	4 ⁽²⁾	with 1/2" hub	4
							St.st knob			
							St.st knob			
							without	0		
							6	1	AC	
							12	2	8W50Hz	
							24	3	AC	
							48	4	8W60Hz	
							110	5	DC10W	
							120	6		
							230	7		
							240	8		
							other	9		

(1) Only for BSP
(2) Special order

PES5-S | Sol-Spring | 1/4", 1/2" | 5 port

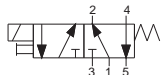

Port size : 1/4"

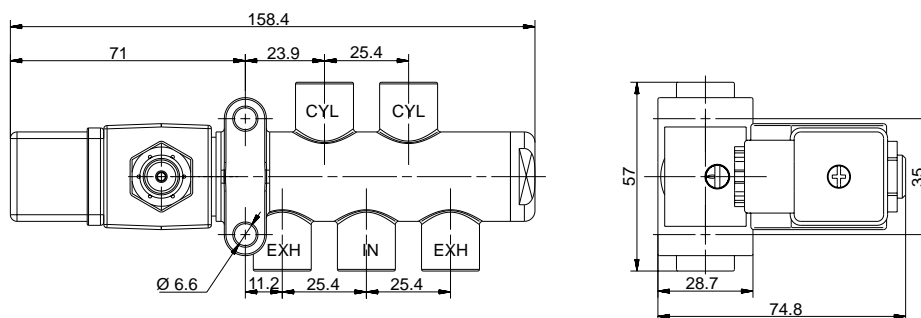

Port size : 1/2"

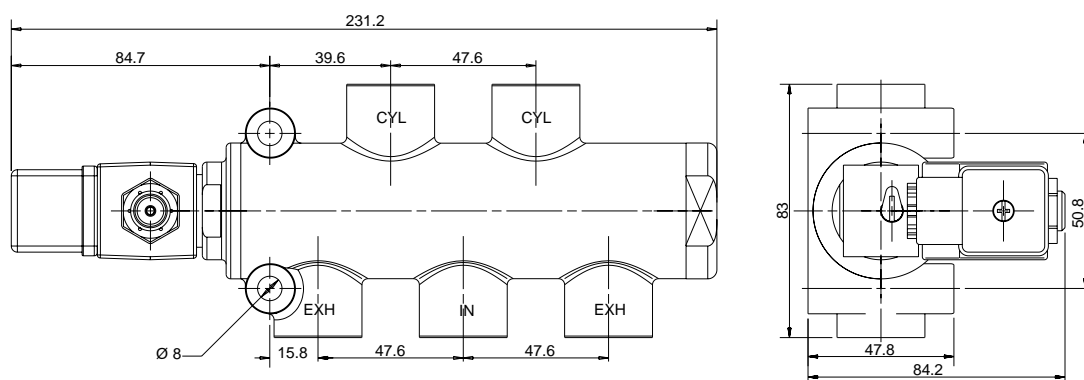

How to Order

PES5	PORT SIZE	S	SEAL MATERIAL	EXTERNAL AIR SUPPLY ⁽¹⁾	MANUAL OVERRIDE	COIL VOLTAGE	POWER	CONNECTOR		
	1/4" BSP	0	NBR	N	without	1	None	0	without	0
	1/4" NPT	1	FKM	V	with	2	Plastic	1	standard	1
	1/2" BSP	2					Brass slot	2 ⁽²⁾	with LED	2
	1/2" NPT	3					non-locking	3 ⁽²⁾	with LED + surge protection	3
							St.st knob	4 ⁽²⁾	with 1/2" hub	4
							locking	5		
							St.st knob	6		
								120		
								230		
								240		
								other		

(1) Only for BSP
(2) Special order

PNEUMATIC VALVES | Brass Heavy Duty PE Series

PE | Solenoid Operated

PES3-D | Sol-Sol | 1/4", 1/2" | 3 port

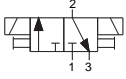

Port size : 1/4"

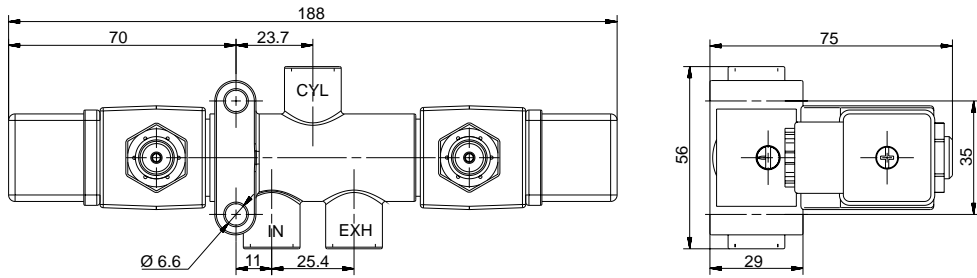

Port size : 1/2"

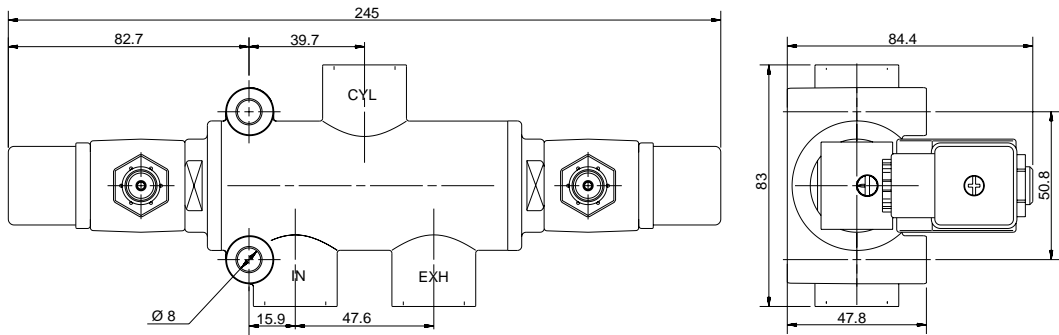

How to Order

PES3	PORT SIZE	D	SEAL MATERIAL	EXTERNAL AIR SUPPLY (1)	MANUAL OVERRIDE	COIL VOLTAGE	POWER	CONNECTOR					
	1/4" BSP	0	NBR	N	without	1	None	0	without	0			
	1/4" NPT	1	FKM	V	with	2	Plastic	1	6	1	AC	standard	1
	1/2" BSP	2					Brass slot	2 ⁽²⁾	12	2	8W50Hz	with LED	2
	1/2" NPT	3					non-locking	3 ⁽²⁾	24	3	AC	with LED + surge protection	3
							locking	4 ⁽²⁾	48	4	8W60Hz		
							St.st knob		110	5	DC10W		
							St.st knob		120	6		with 1/2" hub	4
									230	7			
									240	8			
									other	9			

(1) Only for BSP
(2) Special order

PES5-D | Sol-Sol | 1/4", 1/2" | 5 port

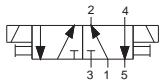

Port size : 1/4"

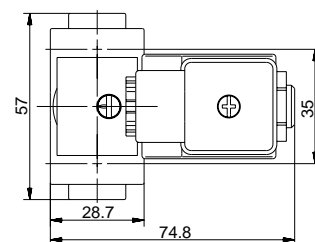
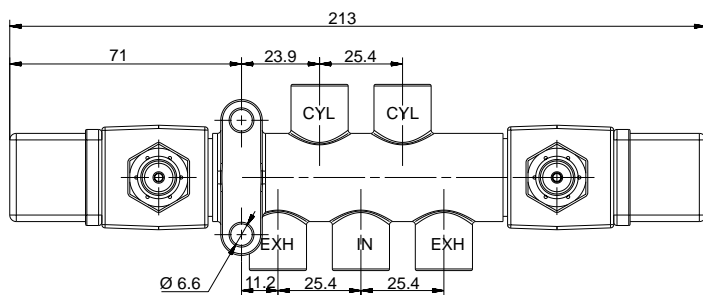

Port size : 1/2"

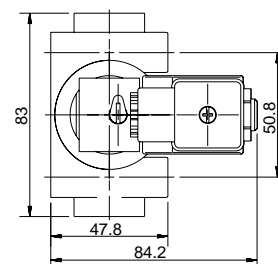
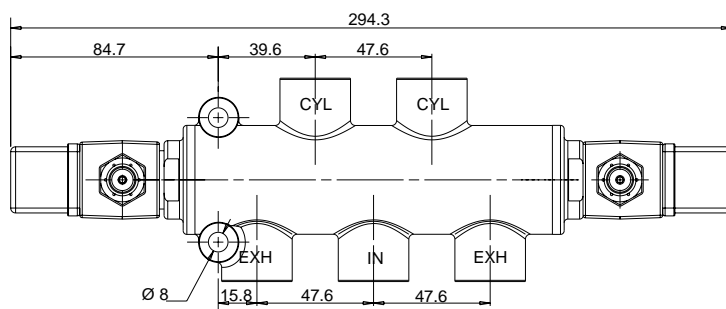

How to Order

PES5	PORT SIZE	D	SEAL MATERIAL	EXTERNAL AIR SUPPLY ⁽¹⁾	MANUAL OVERRIDE	COIL VOLTAGE	POWER	CONNECTOR					
	1/4" BSP	0	NBR	N	without	1	None	0	without	0			
	1/4" NPT	1	FKM	V	with	2	Plastic	1	6	1	AC	standard	1
	1/2" BSP	2					Brass slot	2 ⁽²⁾	12	2	8W50Hz	with LED	2
	1/2" NPT	3					non-locking	3 ⁽²⁾	24	3	AC	with LED + surge protection	3
							locking	4 ⁽²⁾	48	4	8W60Hz		
							locking		110	5	DC10W	with 1/2" hub	4
							St.st knob		120	6			
							St.st knob		230	7			
									240	8			
									other	9			

(1) Only for BSP
(2) Special order

PNEUMATIC VALVES | Brass Heavy Duty PE Series

PE | Solenoid Operated

PES3-A | Sol-Air | 1/4", 1/2" | 3 port

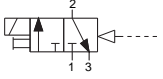

Port size : 1/4"

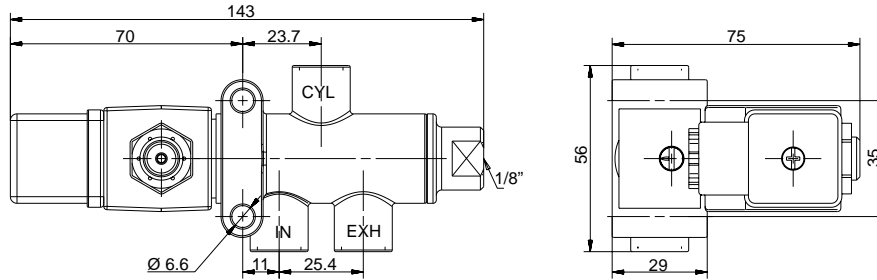

Port size : 1/2"

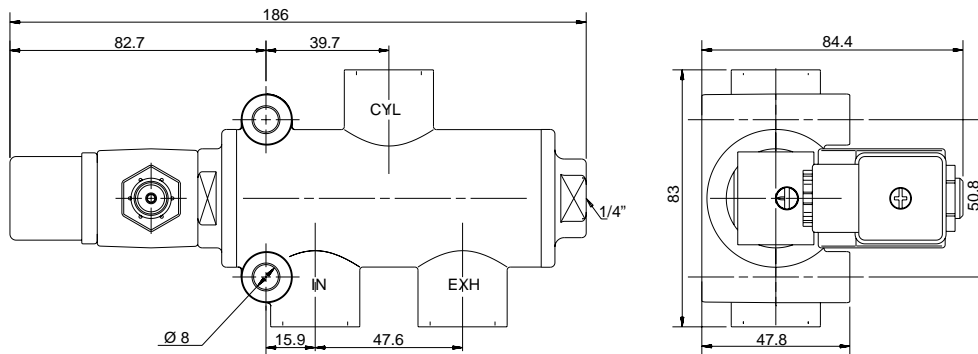

How to Order

PES3	PORT SIZE	A	SEAL MATERIAL	EXTERNAL AIR SUPPLY ⁽¹⁾	MANUAL OVERRIDE	COIL VOLTAGE	POWER	CONNECTOR					
	1/4" BSP	0	NBR	N	without	1	None	0	without	0			
	1/4" NPT	1	FKM	V	with	2	Plastic	1	6	1	AC	standard	1
	1/2" BSP	2					Brass slot	2 ⁽²⁾	12	2	8W50Hz	with LED	2
	1/2" NPT	3					non-locking	3 ⁽²⁾	24	3	AC	with LED + surge protection	3
							locking	4 ⁽²⁾	48	4	8W60Hz		3
							locking	4 ⁽²⁾	110	5	DC10W	with 1/2" hub	4
							St.st knob	4 ⁽²⁾	120	6			
							St.st knob	4 ⁽²⁾	230	7			
									240	8			
									other	9			

(1) Only for BSP
(2) Special order

PES5-A | Sol-Air | 1/4", 1/2" | 5 port

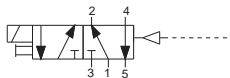

Port size : 1/4"

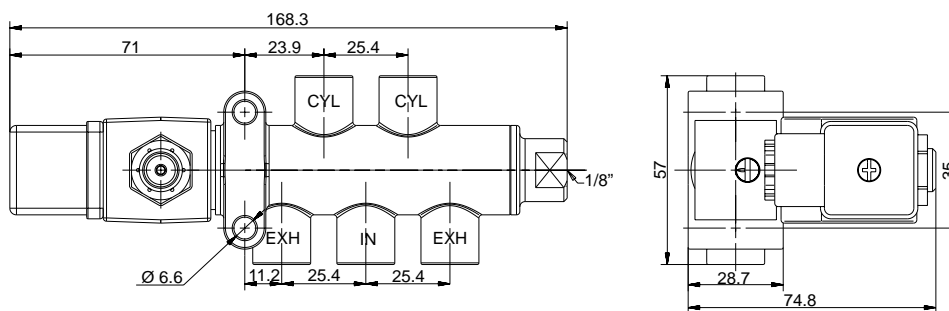

Port size : 1/2"

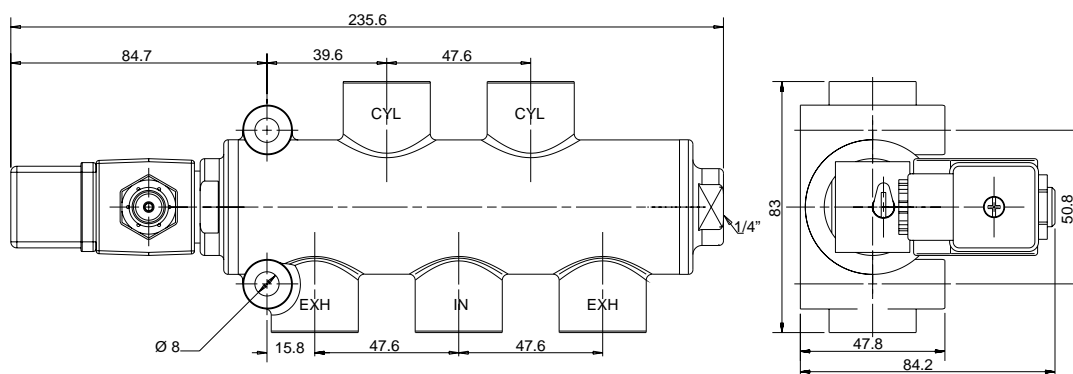

How to Order

PES5	PORT SIZE	A	SEAL MATERIAL	EXTERNAL AIR SUPPLY ⁽¹⁾	MANUAL OVERRIDE	COIL VOLTAGE	POWER	CONNECTOR						
	1/4" BSP	0	NBR	N	without	1	None	0	without	0				
	1/4" NPT	1	FKM	V	with	2	Plastic	1	6	1	AC	1	standard	1
	1/2" BSP	2					Brass slot	2 ⁽²⁾	12	2	8W50Hz	1	with LED	2
	1/2" NPT	3					non-locking	3 ⁽²⁾	24	3	AC	2	with LED + surge protection	3
							locking	4 ⁽²⁾	48	4	8W60Hz	2		
							St.st knob		110	5	DC10W	3	with 1/2" hub	4
							St.st knob		120	6				
									230	7				
									240	8				
									other	9				

(1) Only for BSP
(2) Special order

PNEUMATIC VALVES | Brass Heavy Duty

PE Series

PE | Solenoid Operated

PES5-P | 3 Position Closed Center | Sol-Sol | 1/4" | 5 port

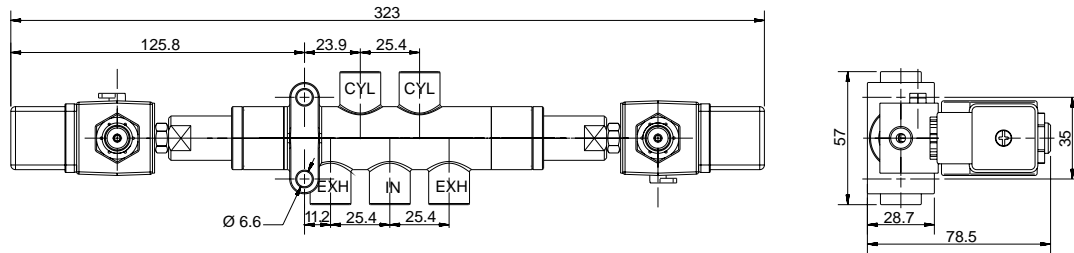
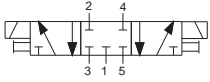

PES5-U | 3 Position Exhaust Center | Sol-Sol | 1/2" | 5 port

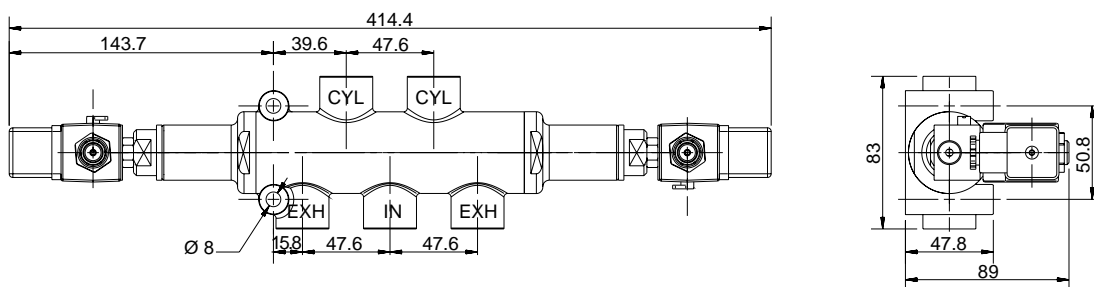
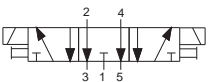

How to Order

PES5	PORT SIZE	FUNCTION	SEAL MATERIAL	EXTERNAL AIR SUPPLY ⁽¹⁾	MANUAL OVERRIDE	COIL VOLTAGE	POWER	CONNECTOR
	1/4" BSP 0	Closed Center	NBR	N	without 1	without 0	none 0	without 0
	1/2" BSP 2	Center	FKM	V	with 2	6 1	AC 8W50Hz 1	standard 1
		Exhaust Center			Brass slot 2 ⁽²⁾	12 2		with LED 2
					non-locking St.st knob 3 ⁽²⁾	24 3	AC 8W60Hz 2	with LED + surge protection 3
					locking St.st knob 4 ⁽²⁾	48 4		
						110 5	DC10W 3	
						120 6		with 1/2" hub 4
						230 7		
						240 8		
						other 9		

(1) Only for BSP
(2) Special order